

8|ACOUSTICS

Micro-C / Micro Kit

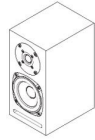

User Manual



	Micro-C	Micro
Technical specification :		
Frequency range	68 - 28000 Hz+/-3 dB	70-28000 Hz +/-3 dB
Sensitivity (2.83V / 1m)	84.5 dB	84.5 dB
Nominal impedance	4Ω	4Ω
Max SPL	100 dB	100 dB
Recommended amplifier	25 - 100 W	25 - 100 W
Cross-over frequency	4000 Hz	4000 Hz
Speaker type	2-way Bookshelf	2-way Bookshelf
Enclosure type	Bass reflex	Bass reflex
Port tuning frequency	49 Hz	49 Hz
Drive Units:		
High frequency driver	SB19ST-C000-4	SB19ST-C000-4
Low frequency drivers	4in SB12CAC25-4	4" SB12PAC25-4
Cabinet:		
	15mm MDF	15mm MDF
Dimensions (H x W x D)	262 x 132 x 170 mm 10.3 x 5.2 x 6.7 inch	260 x 130 x 170 mm 10.2 x 5.1 x 6.7 inch
Net weight (pair):		
Cabinet only	4.3 kg / 9.48 lb	4.2 kg / 9.26 lb
Full assembly	7.8 kg / 17.2 lb	7.4 kg / 16.32 lb
Special Features:		
<ul style="list-style-type: none"> - High performance compact design - Optimized drivers - Simple high quality cross-over network - Front firing integrated port - Versatile placement - Solid single wiring binding posts 		



Frequency response (Micro-C)

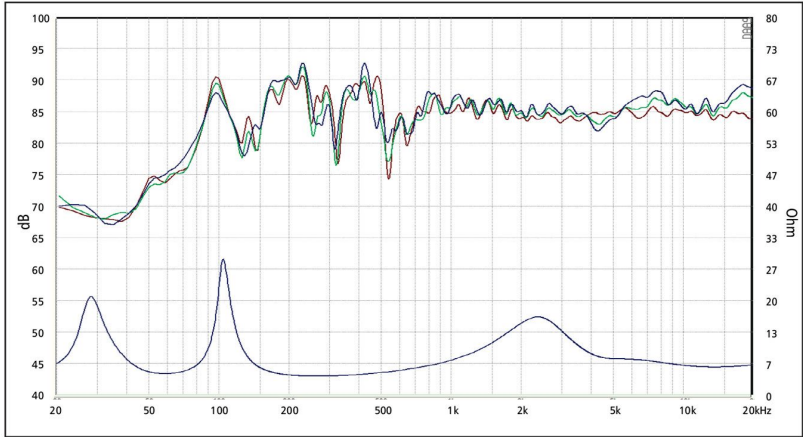

Frequency response (Micro)

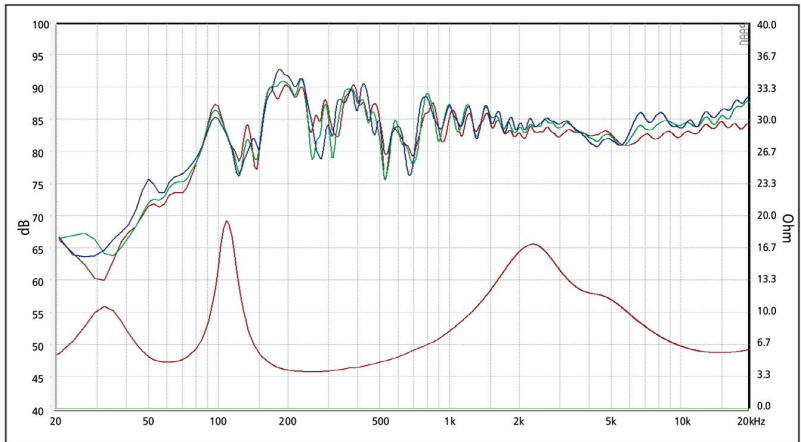

Response Curve :
— (Blue) : on axis — (Green) : 15° off-axis — (Red) : 30° off-axis

Measured on-axis, 15° and 30° off-axis at 1 m in an ordinary room. Lower frequency dips and peaks are caused by room modes/reflections.

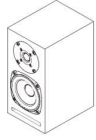

Mechanical drawing (size in mm) / Micro-C

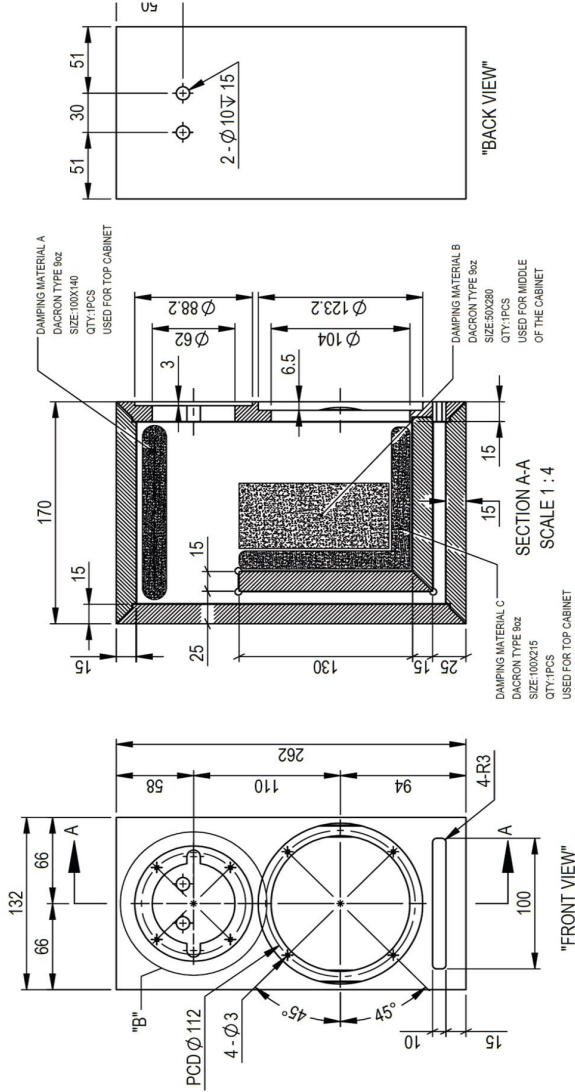



Mechanical drawing (size in mm) / Micro

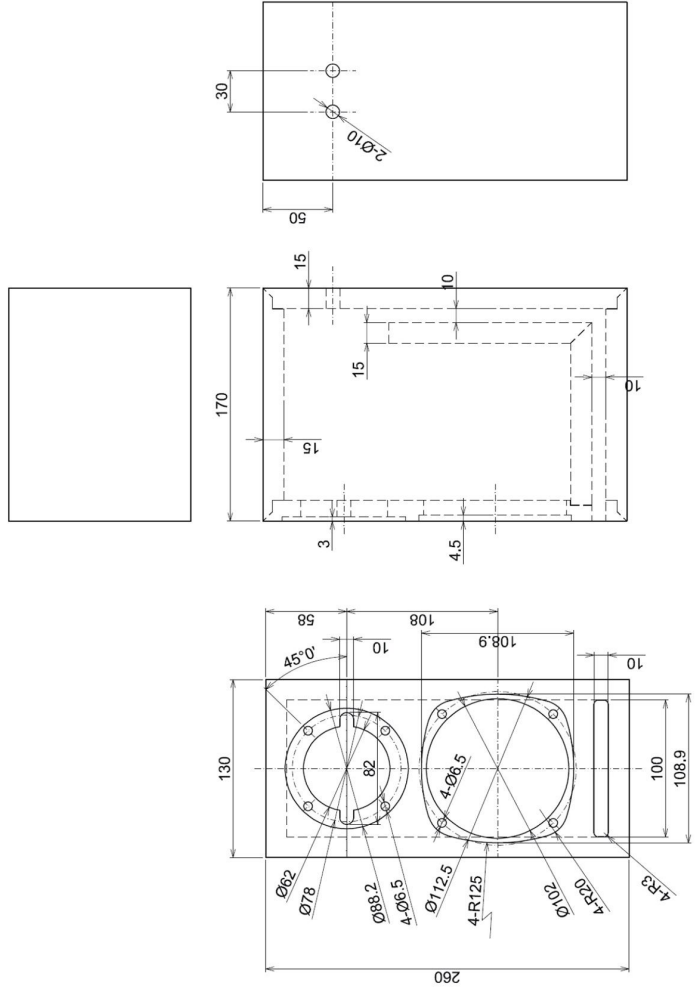

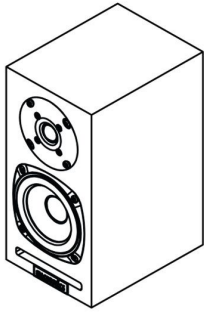
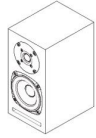

ISOMETRIC VIEW (MICRO)

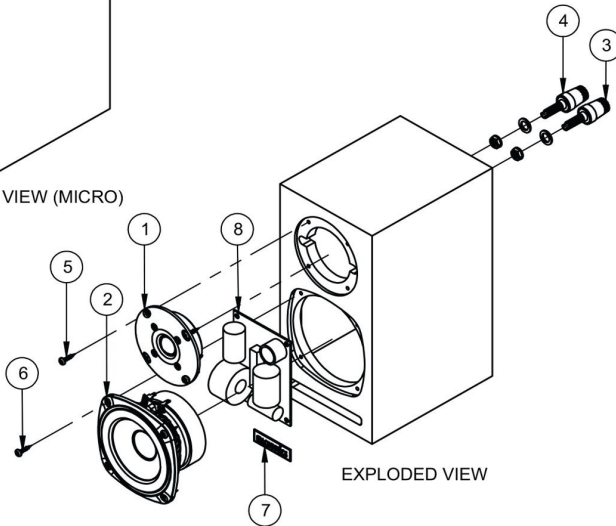

EXPLODED VIEW

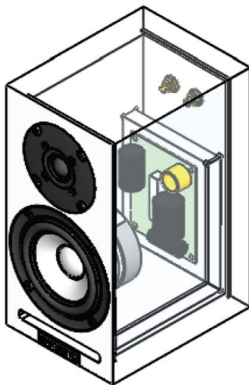

ISOMETRIC VIEW (MICRO-C)

NO.	PART LIST	QTY.
1	SB19ST-C000-4 (Sold separately)	1
2	4in SB12PAC25-4 Or 4in SB12CAC25-4 (Sold separately)	1
3	Binding Post (-) (Black)	1
4	Binding Post (+) (Red)	1
5	Wood Screw 3½x20mm (Not included)	4
6	Wood Screw 4x20mm (Not included)	4
7	Name Plate	1
8	Cross Over (Sold separately)	1
9	Damping Material (See cut pattern)	1



Damping Material Cut Pattern (Size in mm)

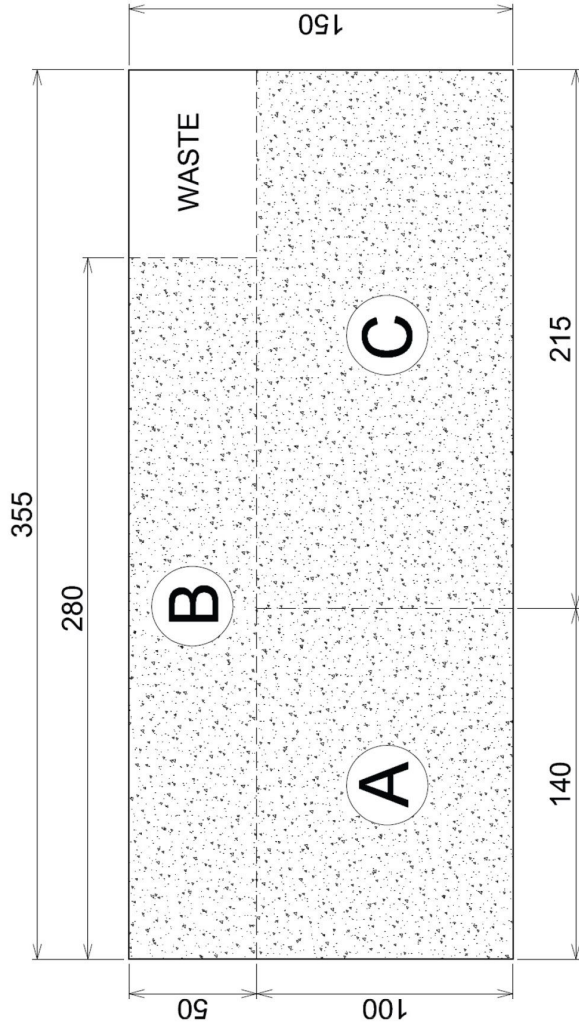

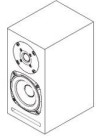

Damping material position (size in mm)

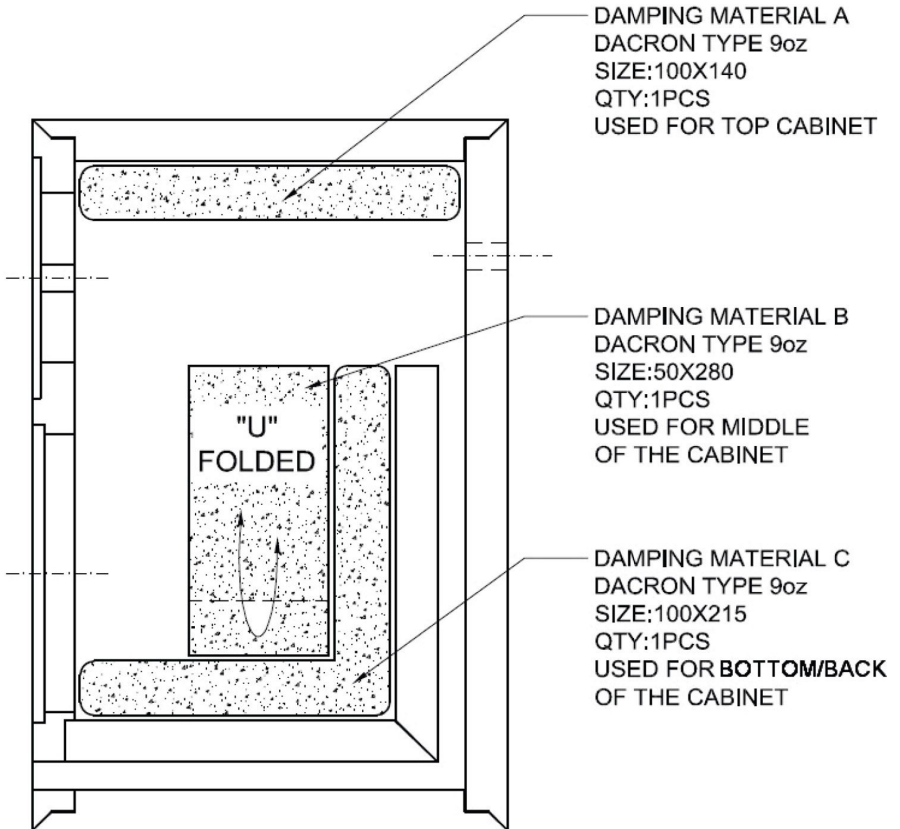



Crossover Schematic

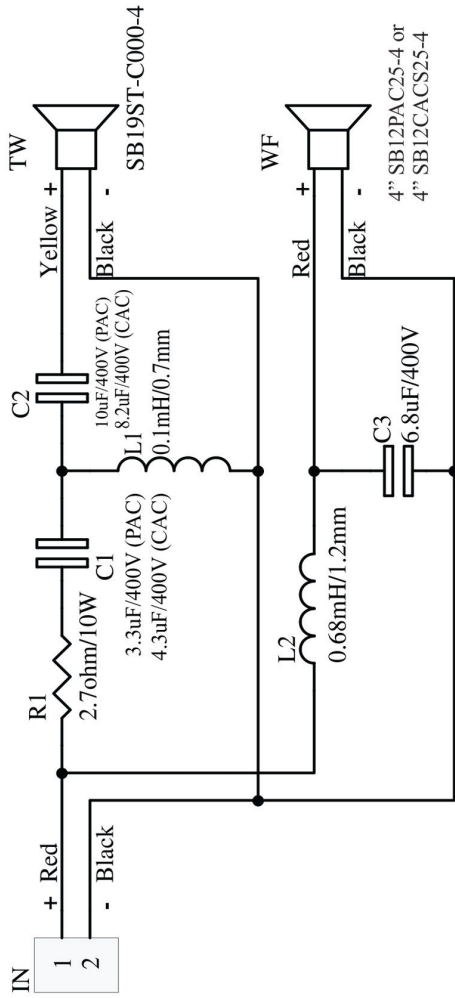

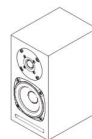

Assembling instruction

Part list (each cabinet):

- High frequency driver SB19ST-C000-4 (sold separately)	1 pc
- Low frequency drivers 4" SB12PAC25-4 or 4" SB12CAC25-4 (sold separately) ..	1 pc
- Micro kit crossover (sold separately).....	1 pc
- Wood Screw 3.5 x 20 mm for tweeter (not included).....	4 pcs
- Wood Screw 4 x 20 mm for woofer (not included).....	4 pcs
- Wood Screw 4 x 16 mm for crossover (from kit crossover).....	4 pcs
- Binding post terminal	1 pair
- Damping	1 pc
- Name plate	1 pc

Tools needed:

- No. 2 Philips screwdriver (for drivers and crossover screw)
- 11 mm hex socket (for tightening binding post nut)
- Soldering iron + tin (for soldering input wire to terminal)
- Multipurpose glue
(for attaching the damping and sealing the terminal hole)



1. Take out the cabinet from the packaging and take out the raw damping material from the cabinet

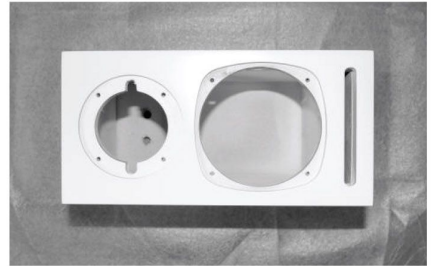

2. Unscrew the binding post nut then attach both binding post terminals on the backside of the cabinet



3. Screw the nut back to the binding post terminal



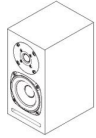

4. Tighten the nut using 11 mm hex socket head. Put some glue around the nut to seal the cabinet.

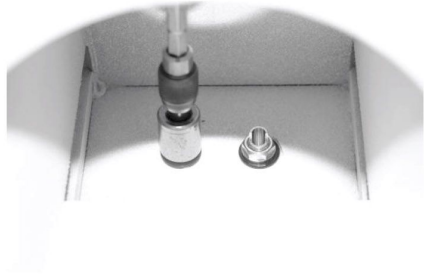

5. Put the crossover on the port panel inside the cabinet

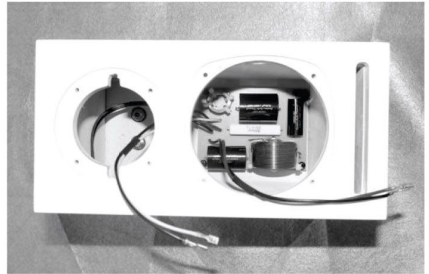

6. Screw the four corners of the crossover to the panel





7. Solder both the crossover input cables to the binding post terminal



8. Cut the raw damping material to 3 pcs of damping according to the cutting diagram

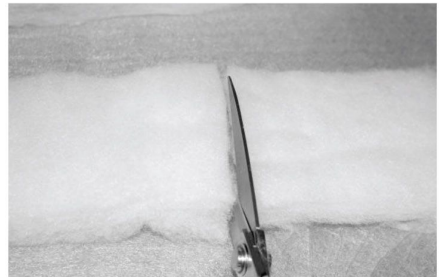

9. Put the each damping part into the cabinet according to damping position diagram. Ad a bit of glue if needed to hold the damping



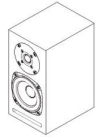

10. Attach the tweeter out cables from the crossover to the tweeter terminals, then put the tweeter into the tweeter hole on the cabinet, align the plate screw hole to the cabinet screw hole

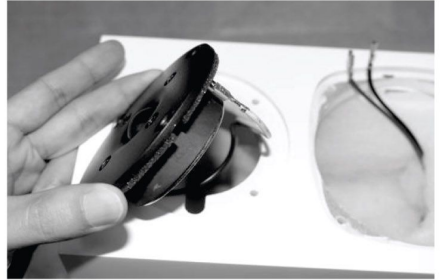

11. Attach the woofer out cables from the crossover to the woofer terminals, then put the woofer into the woofer hole on the cabinet, align the chassis screw hole to the cabinet screw hole

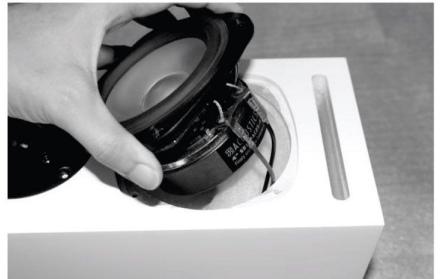

12. Screw both tweeter and woofer to the cabinet



Find Us On



www.sbacoustics.com
