

Model No.: SLS-P830668

Rev: 1

Product Line: Peerless

Last Update: 2017-04-25 14:32:09

Product Description

The SLS line combines high quality performance with an affordable design. This 10 inch 8 ohm member of the SLS family features a rigid steel basket, a coated paper cone, and a ferrite magnet motor with aluminium shorting ring for improved distortion performance.



Mechanical Drawing

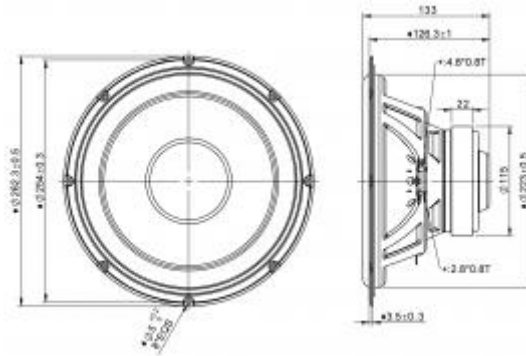

Specifications

DC Resistance	Revc	Ohms	5.61	5.0%	Energy Bandwidth Product	EBP	(1/Qes)*fs
Minimum Impedance	Zmin	Ohms	7.31	7.5%	Moving Mass	Mms	g
Voice Coil Inductance	Le	mH	1.37		Suspension Compliance	Cms	um/N
Resonant Frequency	Fs	Hz	32.4	15%	Effective Cone diameter	D	cm
Mechanical Q Factor	Qms		7.15		Effective Piston Area	Sd	cm^2
Electrical Q Factor	Qes		0.59		Effective Volume	Vas	L
Total Q Factor	Qts		0.55		Motor Force Factor	BL	Tm
Ratio Fs/Qts	F	Fs/Qts	59.23		Motor Efficiency Factor	β	(T*M^2)/Ohms
Half Space Sensitivity @2.83V	db@2.83V/1M	dB	87.9	+/- 1.0db	Voice coil former Material	VCfm	GSV
Half Space Sensitivity @1W/1M	db@1W/1M	dB	87.5	+/- 1.0db	Voice coil inner diameter	VCd	mm
Gap Height	Gh	mm	8		Rated Noise Power	P	W
Maximum Linear Excursion	Xmax	mm	8.3		Test Spectrum Bandwidth		30Hz-2KHz
Ferrofluid Type	FF				Driver Size	Inch	10 in
Driver Mass	Kg		2.7				

Frequency and Impedance Response



Highcharts.com